

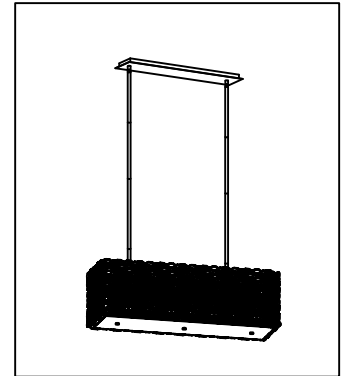

Specification of installation

In order to ensure safety use, please notice the following items:

- Read and understand the whole Specification.
- Suitable for the use of 110~130V and 60Hz.
- Please wear gloves as installment and avoid rot on the surface of plating.
- Must be installed on the fixed places and be checked annually.
- Please turn off the lighting source by soft cloth as cleaning prohibited to use of rotted detergent.
- Please connect with the local sales service center when there are any abnormality.

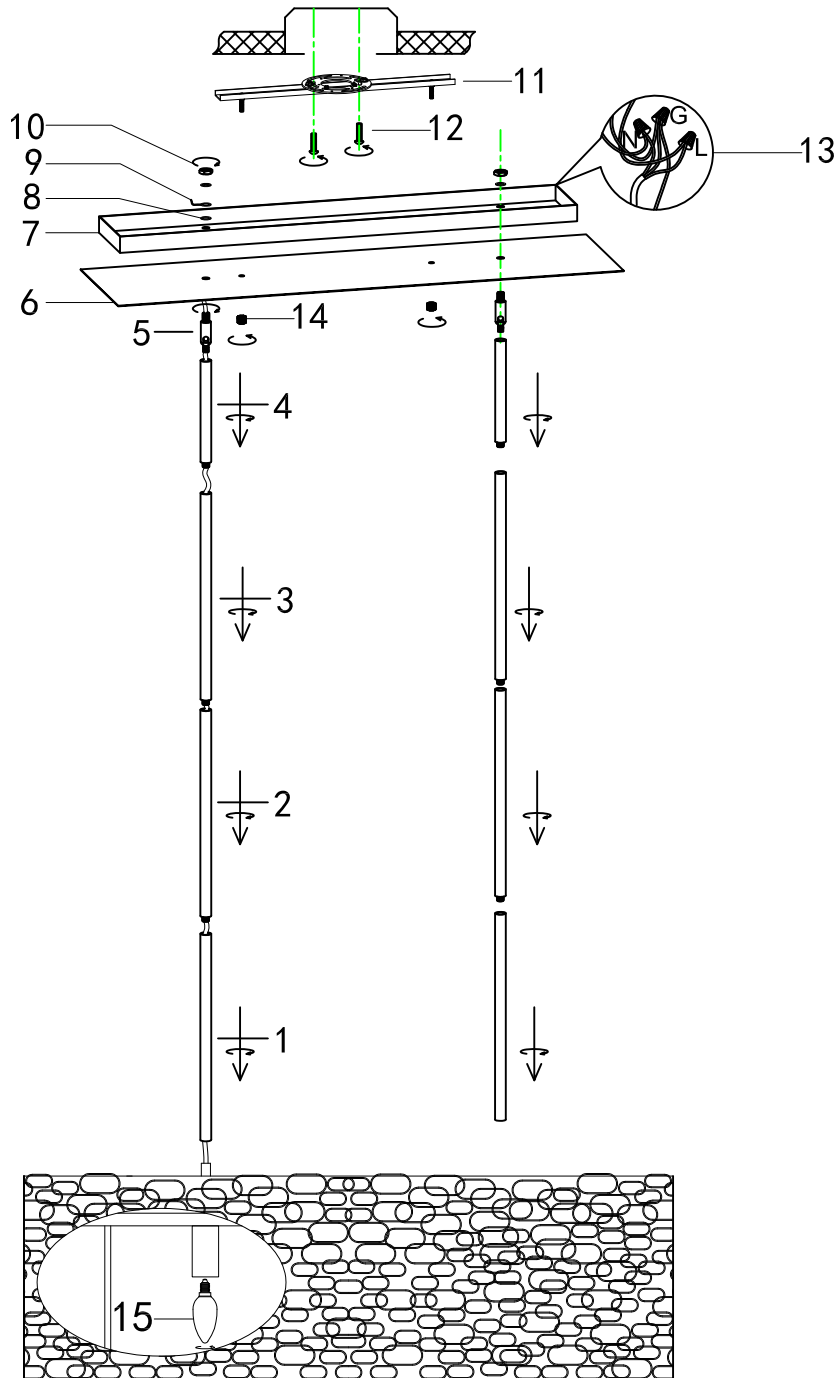

- 1 Screw
- 2 Screw
- 3 Screw
- 4 Screw
- 5 Coupling
- 6 Stainless Steel
- 7 Canopy
- 8 Lock washer
- 9 Ground wire
- 10 Lock Nut
- 11 Mouning
- 12 Screw
- 13 Terminal
- 14 Nut
- 15 E12 bulb

Product coding: HF1701-PN