

### Thank you for your purchase.

Welcome to the Avenue Lighting Family. Please follow these instructions carefully as they contain important information about the safety, use and disposal of this product. Read and understand all instructions before proceeding with assembly and installation of this fixture.

- This fixture **MUST** be installed by a licensed electrician.
- All parts must be used as indicated in this install sheet.
- DO NOT substitute any parts, leave parts out, or use parts that are worn out or broken.
- This fixture is intended for installation in accordance with the National Electrical Code (NEC) and all local code specifications.
- Use **ONLY** the supplied LED driver to power this fixture.
- Do NOT operate fixture if any lights are not operating or are operating improperly in order to prevent further damage.



### Preparation:

Carefully remove the fixture from the carton and check that all parts are included as shown in the illustration. If any parts are missing or damaged, DO NOT attempt to assemble the product.

### Tools Required (not included):

- ~ Phillips screwdriver
- ~ Flathead screwdriver
- ~ Wire Strippers
- ~ Electrical Tape
- ~ Ladder
- ~ Safety Glasses

### Assembly Instructions:

1. Turn off the power before installation (see Figure A)
2. Open the box, take out the fixture and accessories, screw the middle rod onto the lamp body tightly, and secure it with screws for reinforcement (Steps 1 - 2)
3. Open the parrot buckle, hook one end onto the lifting ring of the fixture and the other end onto the hanging chain, then tighten the nut of the parrot buckle (Steps 3 - 4)
4. Drill holes in the ceiling according to the mounting plate holes for the expansion screws, then insert the expansion screws into the holes and tighten them (Steps 5)
5. Thread the wire load-bearing steel wire through the hanging chain, crystal lifting ring, crystal outer ring, ceiling cover, and mounting plate in sequence. Then pass the load-bearing steel wire through the load-bearing beam behind the junction box on the ceiling and securely wrap and fix it around the load-bearing beam (Steps 6 - 8)
6. Place the mounting plate over the junction box, align the holes on the mounting plate with the threads of the expansion screws, insert them through, and secure them with nuts (Steps 9 - 12)
7. Insert the crystal lifting ring on the hanging chain into the U-shaped groove on the mounting plate, then pass the safety bolt on the mounting plate through the crystal lifting ring and secure it in the U-shaped groove (Steps 13 - 14)
8. Connect the fixture's power wires to the main power wires in the junction box (white to white, black to black). Wrap the bare copper wire around the green screw inside the junction box, tighten the green screw into the hole, and then connect the fixture's bare copper ground wire to the bare copper ground wire in the junction box (Steps 15)
9. Pass the ceiling cover through the crystal lifting ring, cover the mounting plate, screw the crystal outer ring onto the crystal lifting ring, and secure the ceiling plate (Steps 16 - 17)
10. Install the light source onto the fixture (Steps 18)
11. Attach the glass accessories to the fixture one by one according to the fixture diagram, and secure them tightly with screws (Steps 19 - 28)
12. Turn on the power (see Figure B)

### Thank you for your purchase.

Welcome to the Avenue Lighting Family. Please follow these instructions carefully as they contain important information about the safety, use and disposal of this product. Read and understand all instructions before proceeding with assembly and installation of this fixture.

- This fixture **MUST** be installed by a licensed electrician.
- All parts must be used as indicated in this install sheet.
- DO NOT substitute any parts, leave parts out, or use parts that are worn out or broken.
- This fixture is intended for installation in accordance with the National Electrical Code (NEC) and all local code specifications.
- Use **ONLY** the supplied LED driver to power this fixture.
- Do **NOT** operate fixture if any lights are not operating or are operating improperly in order to prevent further damage.



### Preparation:

Carefully remove the fixture from the carton and check that all parts are included as shown in the illustration. If any parts are missing or damaged, DO NOT attempt to assemble the product.

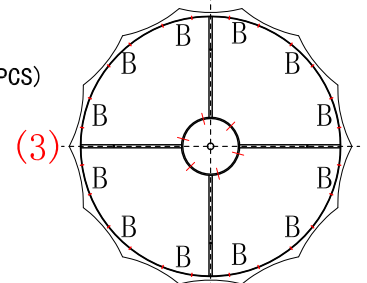
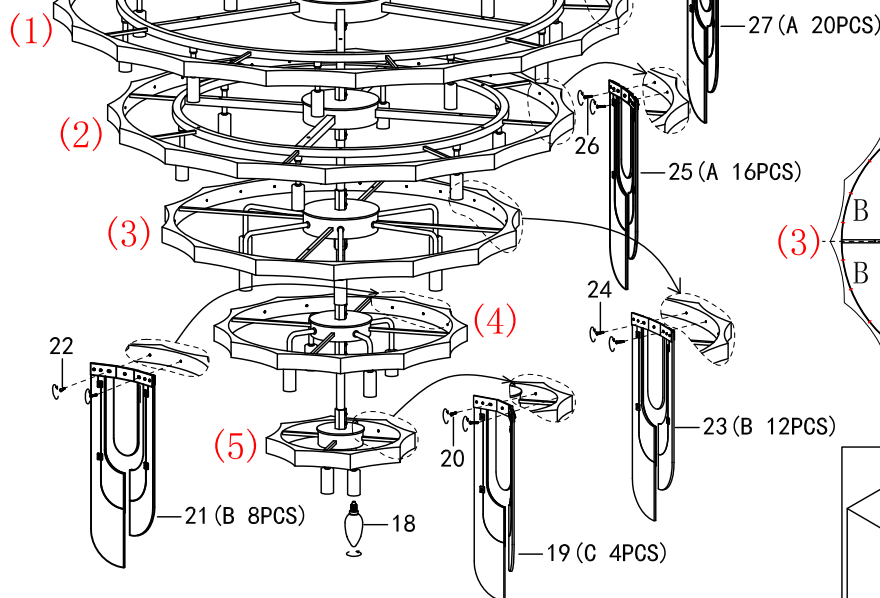
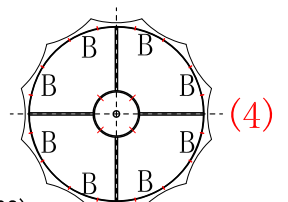
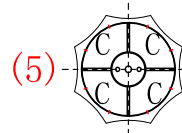
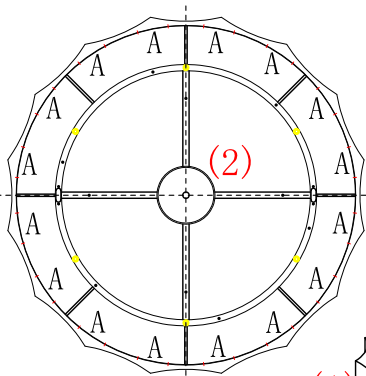
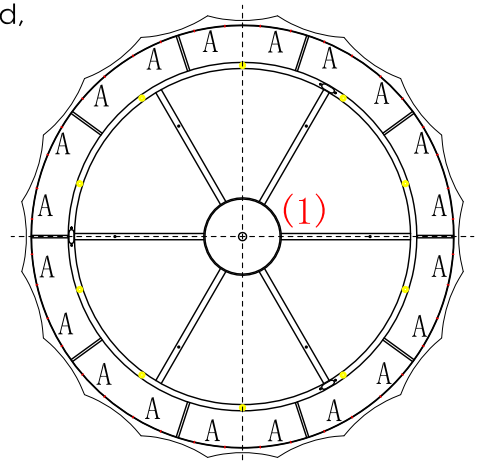
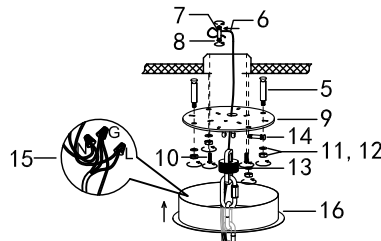
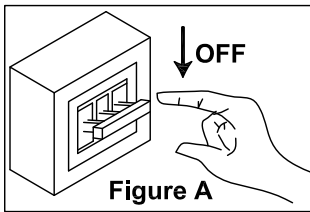

A: 36 PCS  
B: 20 PCS  
C: 4 PCS

