

START FROM HERE

Fixture must be installed by a licensed electrician.

Prepare everything in a clear area.

Wear gloves at all times during this installation.

Read instructions carefully before you start assembly.

Keep this instruction sheet for future reference

AV5636-BLK

WALL LIGHT

Suitable for wet location

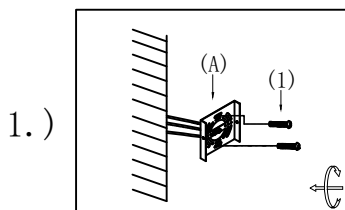

1.) Step 1: Remove mounting bracket from fixture and install to electrical box.

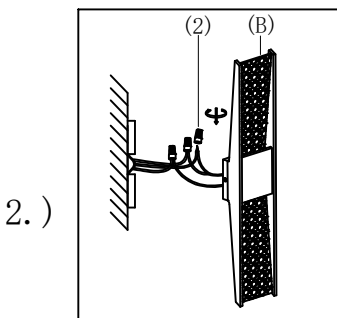

2.) Step 2: Use wire nuts supplied to wire fixture to wires in outlet box. Copper wire is for Ground.

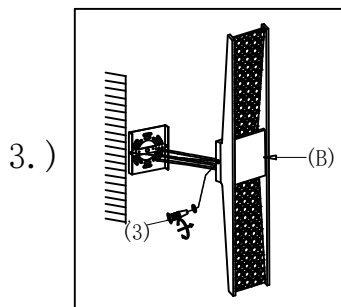

3.) Step 3: Place the fixture on the back plate, and secure with two screws on the sides to hold the fixture in place. Caulk around back-plate where fixture meets the wall using outdoor silicone sealant. Leave a small gap at the bottom to allow moisture to escape.

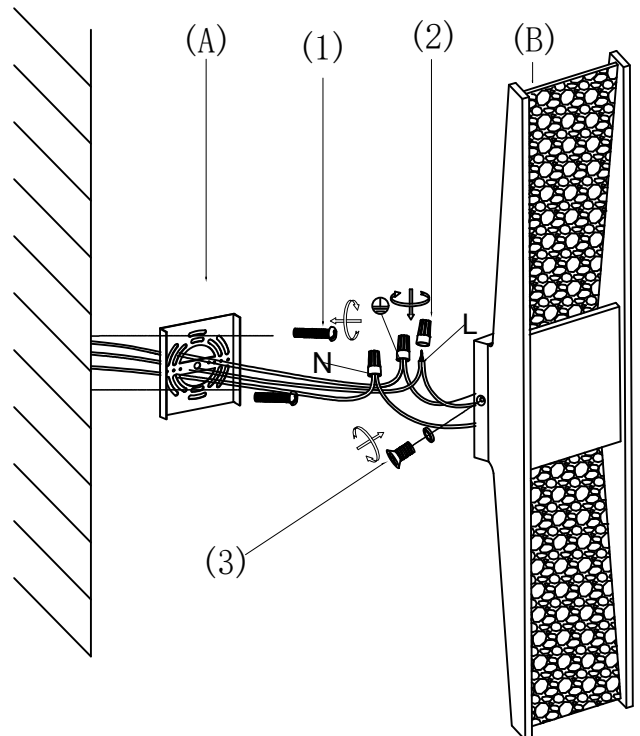

To prevent moisture from entering the outlet box and causing a short, seal around the top and side perimeter between the fixture and the wall surface with weather resistant caulking (see illustration a).

The space at bottom should be left un-caulked to prevent moisture build-up. Apply a small amount of weather resistant caulking around the side perimeter between the cap nut and mounting plate.

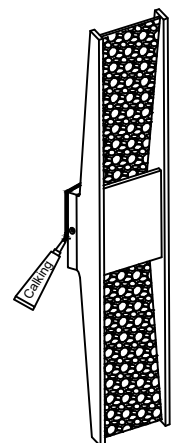

illustration a

Clean with a soft damp cloth.



www.AvenueLighting.com